GET A QUOTE

for Printed Fabric Labels, Ribbons and Tags

ORDER SPECIFICATIONS

Type of Fabric Material - [info on Page 2](#)

The File with the real size graphic - [info on Page 3](#)

The Type of Cut or Fold - [info on Page 4](#)

Quantity in pieces or meters

Description and Notes

CONTACT DETAILS

Contact Name

Company Name

Tel Number

Website, Email

Additional Notes

1. Fill In all fields
2. Save on your desktop
3. Attach the form
4. Attach the graphic file
5. Send to marketing@signal-bg.com

We will come back to you with a quote you can't resist

TYPE OF FABRIC MATERIAL

Here we list all the material we have in stock. For print on a custom material please specify the kind or supply a sample



SATIN MATERIALS [More info](#)

IN WHITE

Polyester Satin High Density

Oeko-tex® 100 Class 1

Polyester Satin High Density coated

Oeko-tex® 100 Class 1

Polyester Satin

Oeko-tex® 100 Class 1

Polyester Satin no optical brighteners

Oeko-tex® 100 Class 1

Polyester Satin double face

Oeko-tex® 100 Class 1

Polyester Satin coated

Oeko-tex® 100 Class 1

Polyester Satin Matte

Oeko-tex® 100 Class 1

Polyester Satin Matte no optical brighteners

Oeko-tex® 100 Class 1

Woven edge Polyester Satin double face

Oeko-tex® 100 Class 1

IN BLACK

Polyester Satin

Oeko-tex® 100 Class 2

Woven edge Polyester Satin double face

Oeko-tex® 100 Class 2

Polyester Satin double face

TAFFETA MATERIALS

Nylon Taffeta - white

Oeko-tex® 100 Class 1

Polyester Taffeta - white

Oeko-tex® 100 Class 1

Acetate Taffeta - white

Oeko-tex® 100 Class 1

Nylon Taffeta no optical brighteners - white

Nylon Taffeta - white

Polyester Taffeta - black

Oeko-tex® 100 Class 2

COTTON MATERIALS

Cotton coated - natural colour

Cotton coated - white

Cotton Herringbone Beige

Cotton Herringbone Black

Cotton Herringbone White

POLYESTER MATERIALS

Polyester Plain white

Polyester Plain black

Polyester Microfibre white

SELF-ADHESIVE MATERIALS

Polyester Satin Self-Adhesive

Nylon Taffeta Self-Adhesive

Polypropylene Self-Adhesive

Paper Self-Adhesive

Polyester Satin Heat Seal

OTHER

Tyvek
Non-woven material
Cardboard paper

ARTWORK CHECK LIST

It is important to check your graphic file before sending it to print!
This will save you time and money!



RASTER IMAGES

min. 240ppi
CMYK Color Mode



VECTOR GRAPHICS

Outlined Graphics (in Curves)*
PANTONE Spot Color Mode

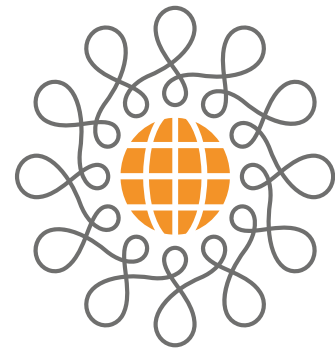

FONTS

Outlined Fonts (in Curves)*
PANTONE Spot Color Mode

85% Cotton
15% Polyester



FILE FORMATS

Pdf, Ai, Eps, Cdr files



*Photoshop file format is only acceptable
for raster images (photographs)!

Ready to go to Print!

TYPE OF CUTS & FOLDS

We can deliver your fabric label on rolls or already cut and folded in a shape of your choice

STRAIGHT CUT



DIAGONAL CUT

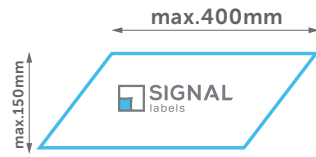

TRAPEZOID CUT

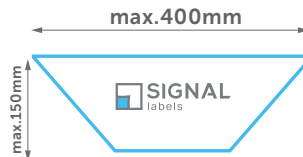

END FOLD

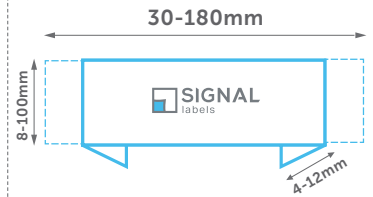

CENTER FOLD

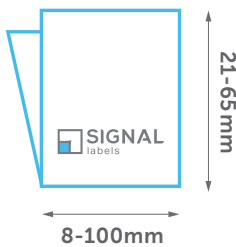

LONG CENTER FOLD

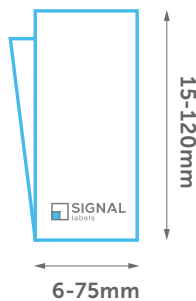

MANHATTAN FOLD CLOSED

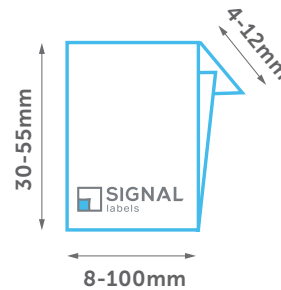

MANHATTAN FOLD OPEN

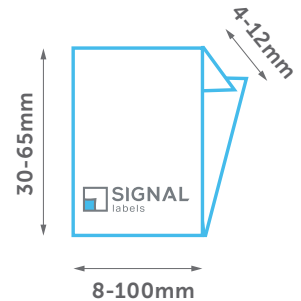

LEAFLET FOLD

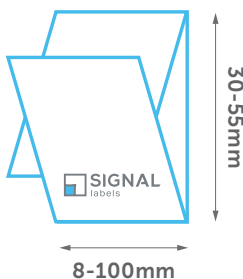

BOOK FOLD

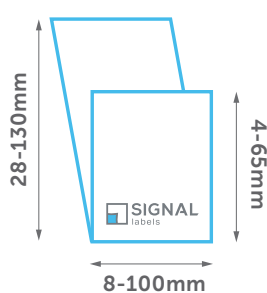

MITRE FOLD

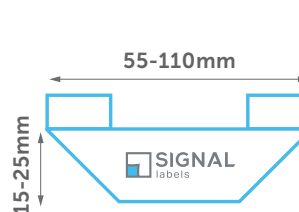

TAG FOLD

